

# Kawasaki Robot

## Y series High-speed picking robot

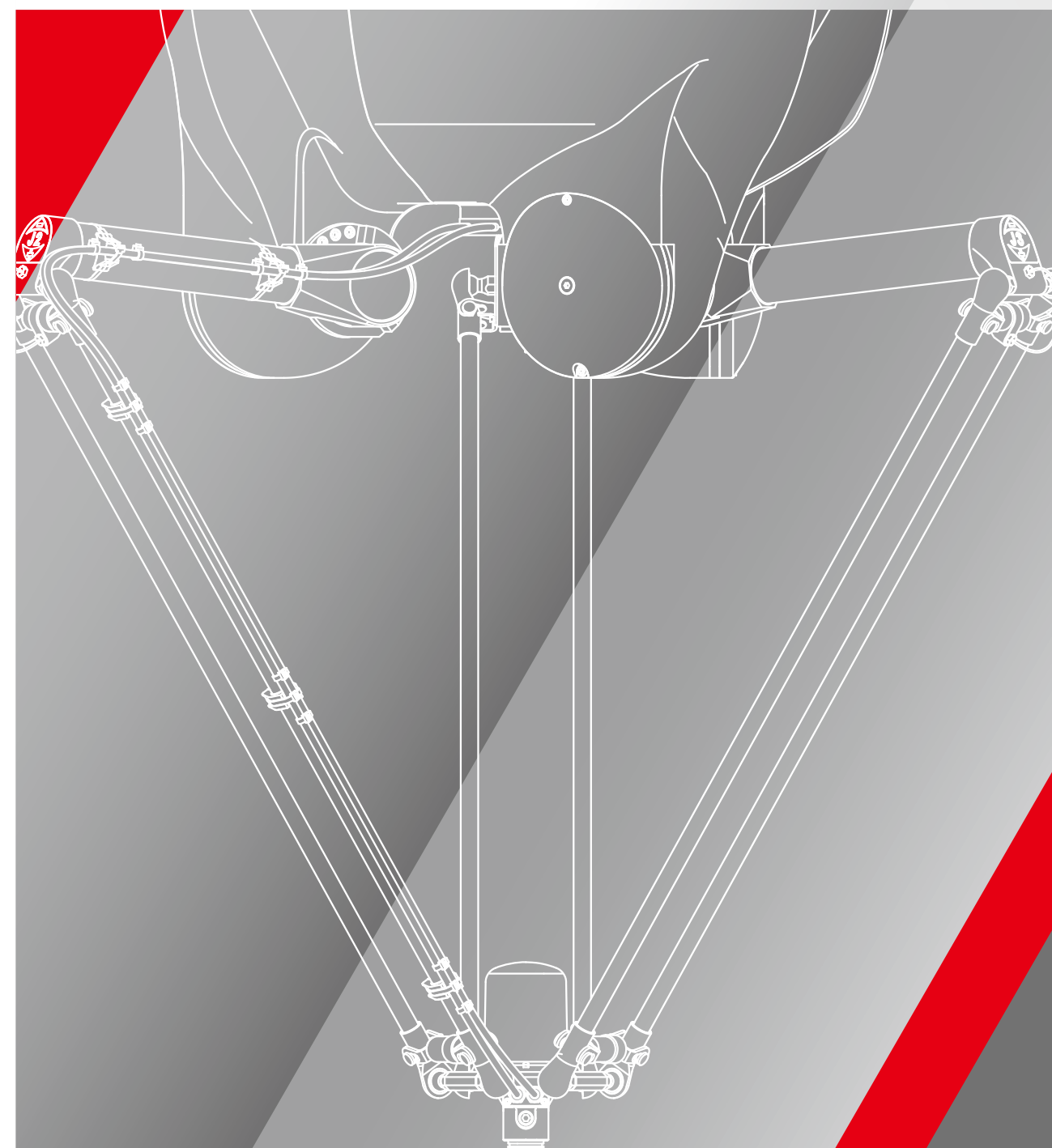

### Kawasaki Heavy Industries, Ltd.

#### ROBOT DIVISION

**Tokyo Head Office/Robot Division**  
1-14-5, Kaigan, Minato-ku, Tokyo 105-8315, Japan  
Phone: +81-3-3435-2501 Fax: +81-3-3437-9880

**Akashi Works/Robot Division**  
1-1, Kawasaki-cho, Akashi, Hyogo 673-8666, Japan  
Phone: +81-78-921-2946 Fax: +81-78-923-6548

#### Global Network

**Kawasaki Robotics (USA), Inc.**  
28140 Lakeview Drive, Wixom, MI 48393, U.S.A.  
Phone: +1-248-446-4100 Fax: +1-248-446-4200

**Kawasaki Robotics (UK) Ltd.**  
Unit 4 Easter Court, Europa Boulevard, Westbrook Warrington  
Cheshire, WA5 7ZB, United Kingdom  
Phone: +44-1925-71-3000 Fax: +44-1925-71-3001

**Kawasaki Robotics GmbH**  
29 Sperberweg, 41468 Neuss, Germany  
Phone: +49-2131-34260 Fax: +49-2131-3426-22

**Kawasaki Robotics Korea, Ltd.**  
43, Namdong-daero 215beon-gil, Namdong-gu, Incheon, 21633,  
Korea  
Phone: +82-32-821-6941 Fax: +82-32-821-6947

**Kawasaki Robotics (Tianjin) Co., Ltd.**  
1-2/F, Building 6, No.19 Xinhuan Road, TEDA, China  
Phone: +86-22-5983-1888 Fax: +86-22-5983-1889

**Kawasaki Motors Enterprise (Thailand) Co., Ltd.**  
(Rayong Robot Center)  
119/10 Moo 4 T.Pluak Daeng, A.Pluak Daeng, Rayong 21140  
Thailand  
Phone: +66-38-955-040-58 Fax: +66-38-955-145

<https://robotics.kawasaki.com/>

## Kawasaki Robot

### CAUTIONS TO BE TAKEN TO ENSURE SAFETY

- For those persons involved with the operation / service of your system, including Kawasaki Robot, they must strictly observe all safety regulations at all times. They should carefully read the Manuals and other related safety documents.
- Products described in this catalogue are general industrial robots. Therefore, if a customer wishes to use the Robot for special purposes, which might endanger operators or if the Robot has any problems, please contact us. We will be pleased to help you.
- Be careful as Photographs illustrated in this catalogue are frequently taken after removing safety fences and other safety devices stipulated in the safety regulations from the Robot operation system.

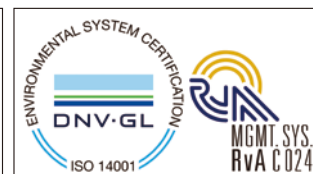

ISO certified in Akashi Works.

# For speed up production lines —

The “Y series” high-speed pick & place robots are ideal for a wide range of applications, including food, pharmaceutical, and cosmetics production lines, as well as the assembly and placement of electrical, electronic, and machine parts. The “Y series” includes two models: the YF003N, with a 3-kg payload capacity, and the YF002N with a 2-kg payload capacity. They are capable of high-speed motion over a wide range, which helps speed up production lines.

YF002N



YF003N



## Features

### High-processing capability

The YF003N boasts speeds of 222 cycles per minute for a 1-kg payload operation, in a to-and-fro motion, with an upward stroke of 25 mm, a horizontal stroke of 305 mm, and then a downward stroke of 25 mm. Meanwhile the YF002N offers speeds of 200 cycles per minute for a 0.5-kg payload operation, in a to-and-fro motion, with an upward stroke of 25 mm, a horizontal stroke of 305 mm, and then a downward stroke of 25 mm. The high-processing ability contributes to takt time reduction.

### Large motion range

The expanded line of products, including the YF002N, with a motion range of 600 mm in diameter and 200 mm in vertical direction, and the YF003N, with a motion range of 1,300 mm in diameter and 500 mm in vertical direction, covers various types of workpieces and production lines.

### High accuracy

High repeatability ensures accurate pick & place operation and high productivity.

### High-density layout

The YF002N, with its more compact structure and smaller footprint, enables the high-density layout of multiple robots. The lighter body can also be installed on a cantilever mount.

### Readily compatible with the Vision system

The series can offer high-speed, high-precision, and safe transfer in combination with a visual sensing system. The YF002N's top mounting base is provided with a hollow space at the center for installing a camera.

### Wash-downs with acid or alkaline cleanser (For the YF003N)

The arm is designed for wash-downs with acid or alkaline cleanser, thus assuring hygiene in production plants.

### Use of food-safe grease and oil for food-processing machinery

Grease and oil for food-processing machinery is used for moving parts to assure hygiene in case of unforeseeable accidents.

### Easy maintenance

The simple, center-drive shaftless design results in easy maintenance. The YF002N is designed so that the main parts can be exchanged in units, greatly facilitating the task of exchanging parts.



		YF002N	YF003N
Type		Parallel link type	
Max. payload (kg)		2	3
Degree of freedom (axes)		4	
Motion range (mm)		ø 600 x H200	ø 1,300 x H500
Cycle time (Payload) *1		0.3 s (0.5 kg) 0.36 s (2 kg)	0.27 s (1 kg) 0.45 s (3 kg)
Positional repeatability (mm) *2		±0.04	±0.1
Angular repeatability (°)		±0.1	
Mass (kg)		60	145
Body color		Munsell 10GY9/1 equivalent	
Installation		Ceiling	
Environmental condition	Ambient Temperature (°C)	10 - 40	0 - 45
	Relative Humidity (%)	35 - 85 (No dew, nor frost allowed)	
Power requirements (kVA) *3		3.0	4.0
Degree of protection	Standard	IP65	
	Option	-	IP67
Controller	America	E97	
	Europe	E91	
	Japan & Asia	E94	

\*1: Motion pattern (25mm up, 305mm horizontal, 25mm down in a to-and-fro motion)  
 \*2: conforms to ISO9283  
 \*3: depends on the payload and motion patterns

YF002N

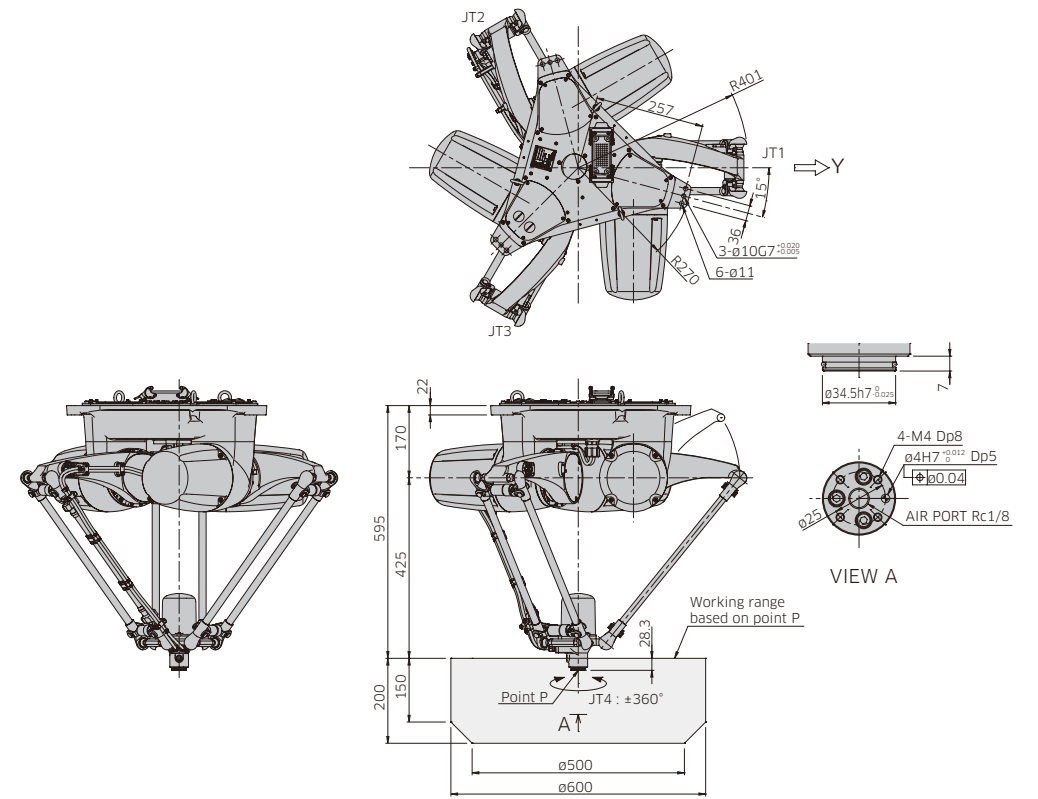

(mm)

YF003N

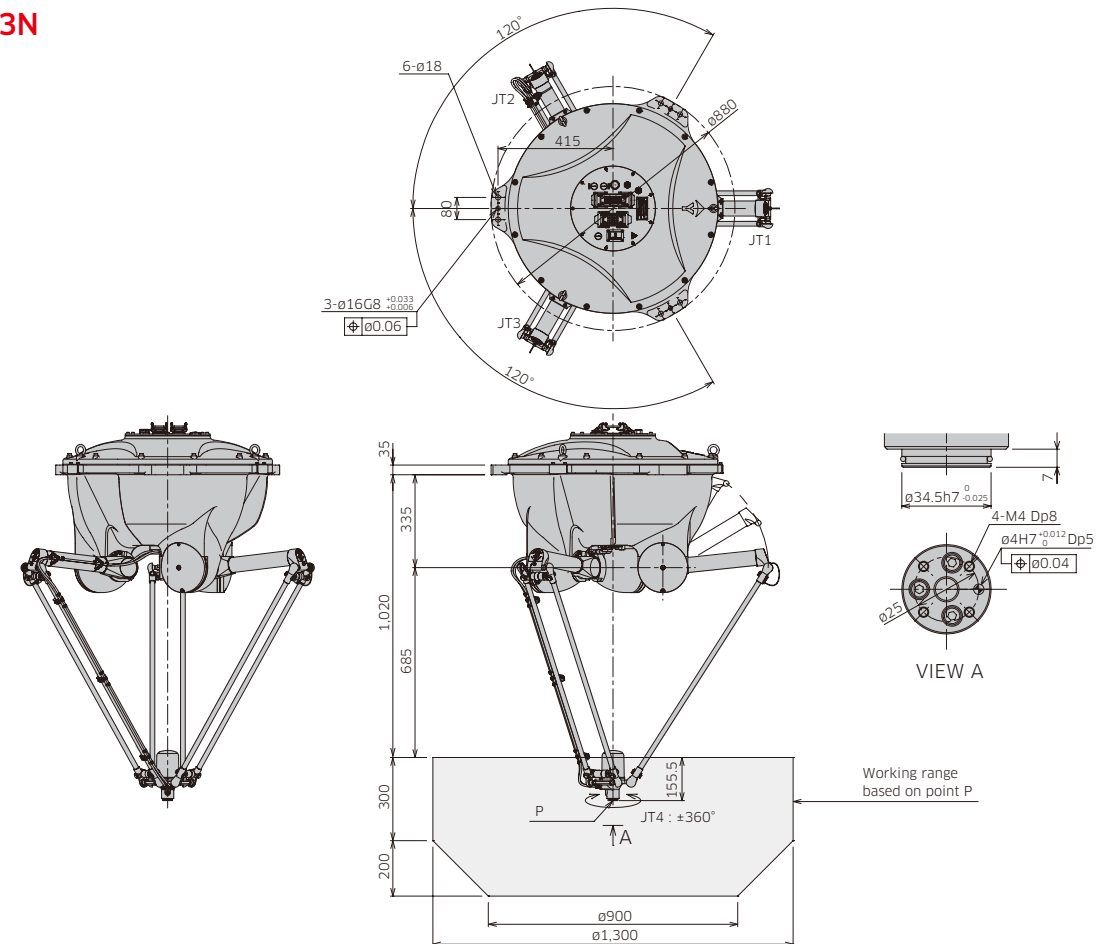

(mm)





## System application examples

Comprehensive robotic solutions for picking, packing, and palletizing, allowing for the automation and streamlining of various processes that enable efficiencies

### Automation of simple tasks

High-speed picking, placing, and packing of sweets, retort foods, frozen foods, and other foods on packing lines

High-speed placement and color identification of cosmetics and medical product containers on filling lines

Placing of packaged instant food and retort-food trays on sterilized lines

### Sorting and placing of products based on camera inspection results

After inspecting the products transferred by the conveyor, such as wafers for solar cells, by an inspection camera, sort and place the products using pickStar.

Products judged as defective by inspection are ejected onto a reject table.

Y-series robots combined with the Vision system can accommodate a variety of product types, with no need to extensively modify the robot hardware.

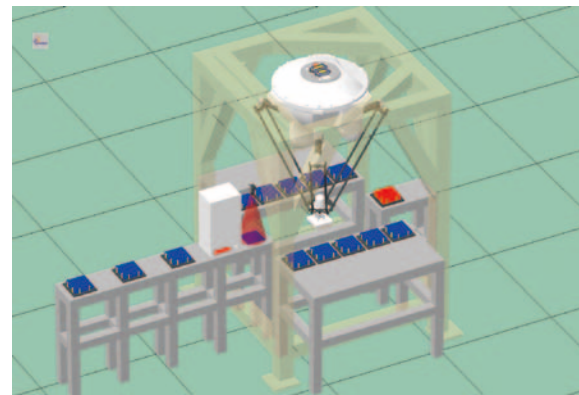
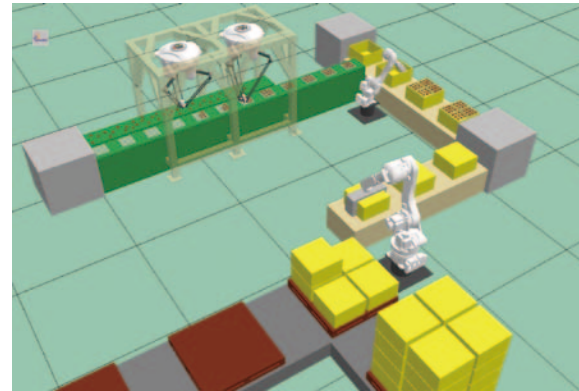

### Layout example

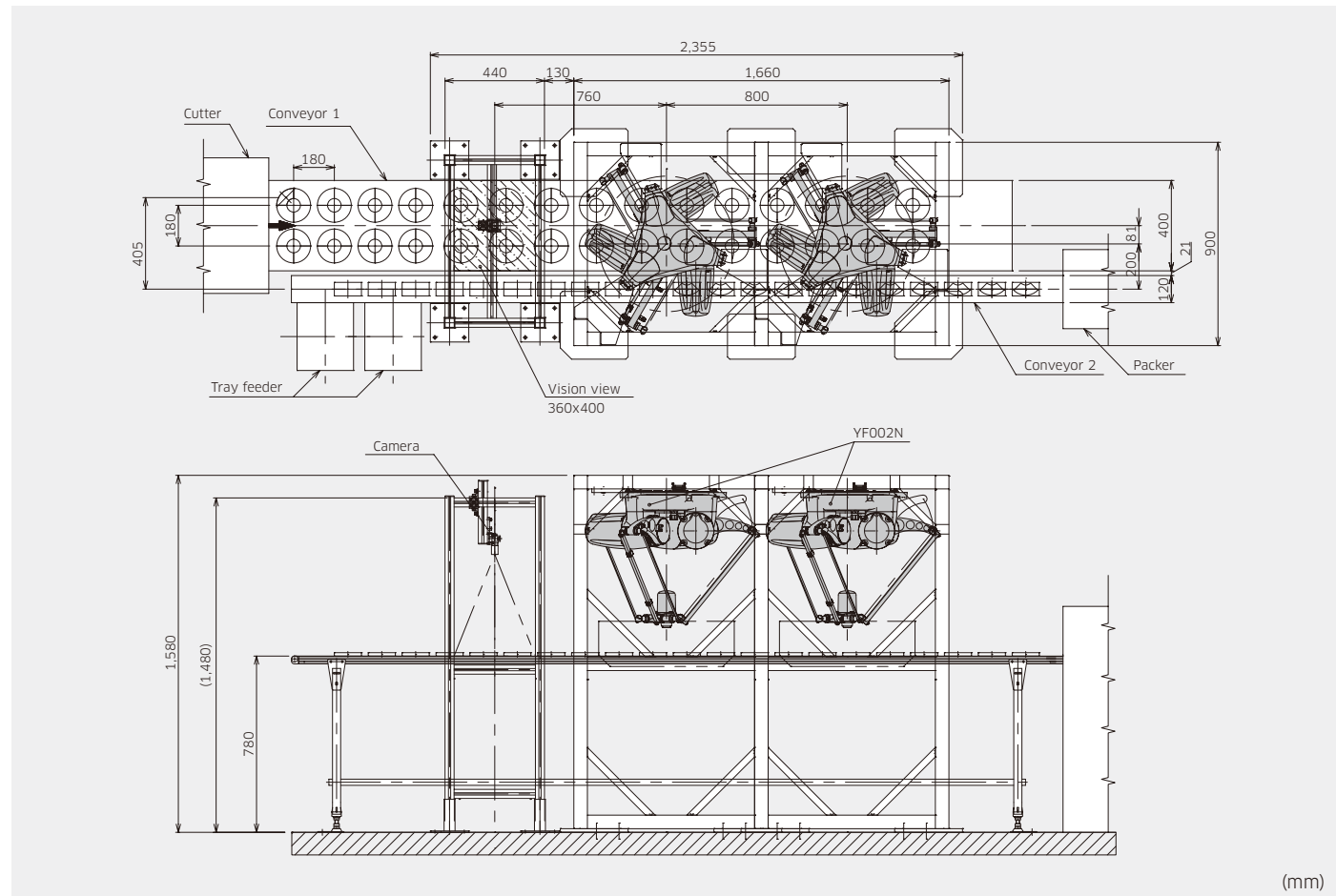

## Robot end effector types

A wide range of variations

Robot end effectors are available in a wide range of variations to suit your needs.

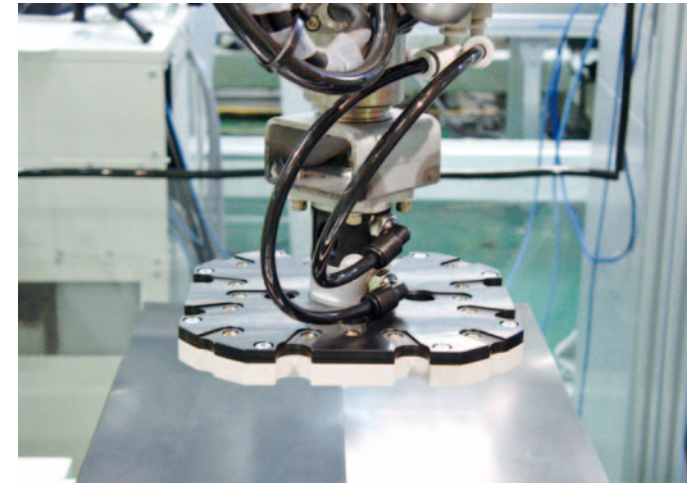

Wafer gripper

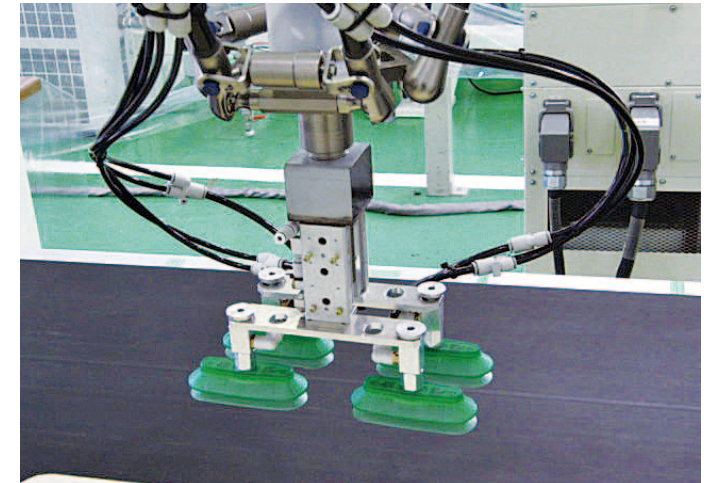

Double gripper for handling sweets

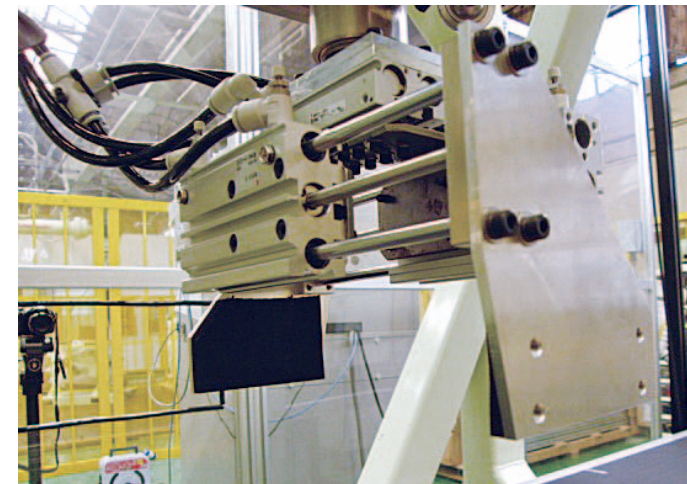

Chuck jaw gripper for handling boxes

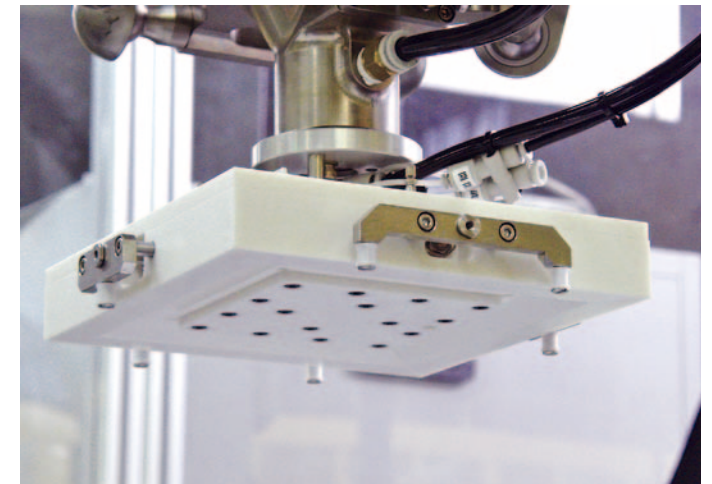

Bernoulli gripper for handling wafers



Double gripper for handling packages

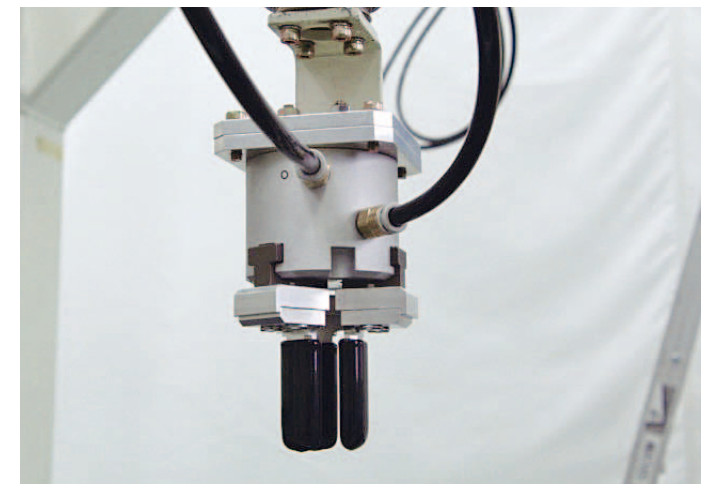

Three-finger gripper for handling tubular workpieces



## Simulation Tool

K-ROSET lets you use your computer to program robots and perform simulations.

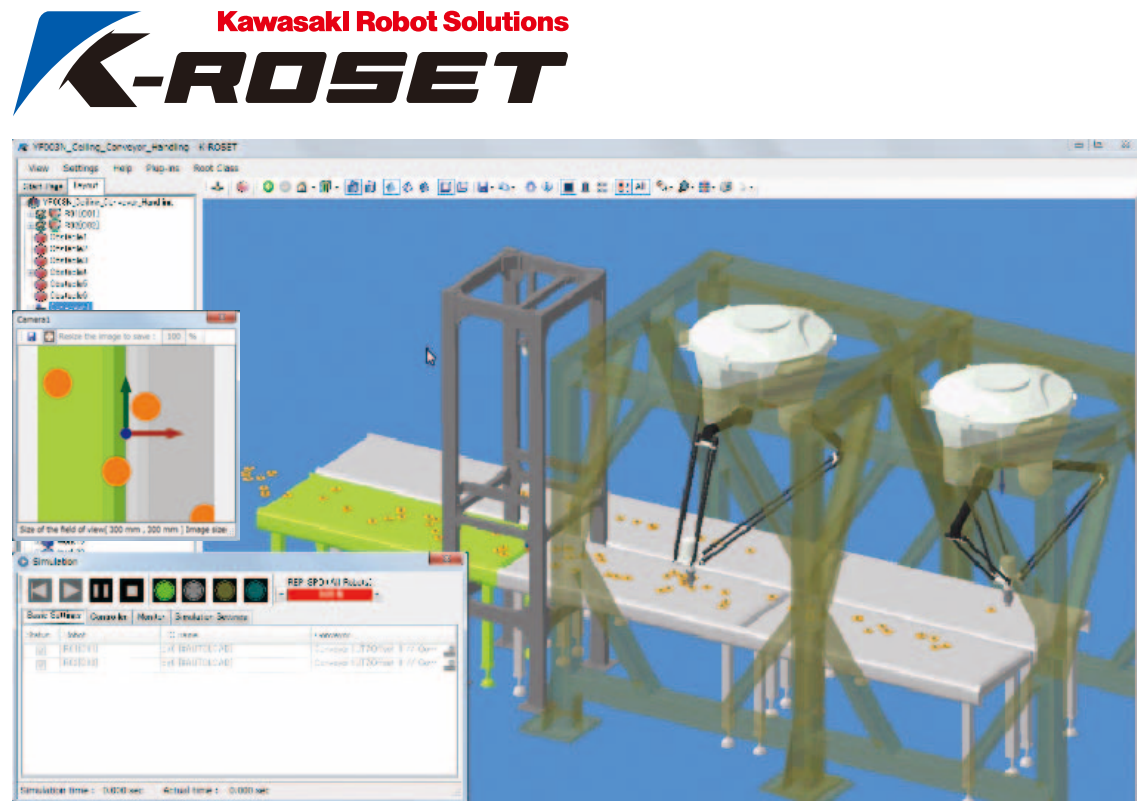

## Features

It allows users to create models of multiple robot systems through the interactive input of parameters. The models help to verify the workload-sharing patterns between robots. (The verification using many robots needs the K-VAssist. Please contact our sales office for details.)

K-ROSET can reproduce practically the same operation trajectories as an actual robot. It can even simulate variations between supplied workpieces, enabling highly accurate cycle-time verification.

The camera's field of vision can be checked by the virtual camera of K-ROSET.

Robot programs verified in simulations are compatible with real robot operations, with few modifications. (Making additional adjustments to the teaching points are required during installation.)

OS environment: Windows 7/10 (x86, x64\*)

\*On a 64-bit computer, it runs in the 32-bit compatible mode.

## Kawasaki vision system

High performance vision system, applied to various usages flexibly and immediately

### Kawasaki vision soft

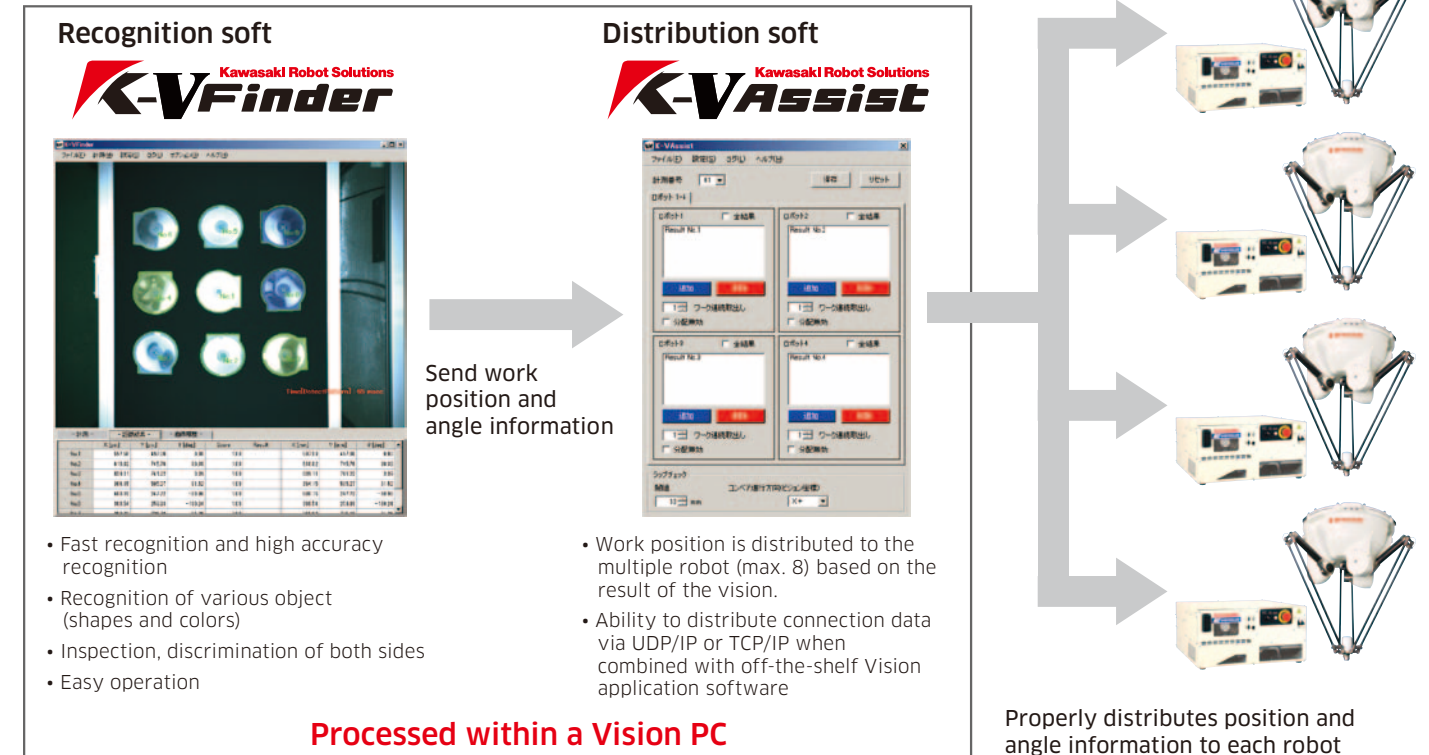

### System configuration example

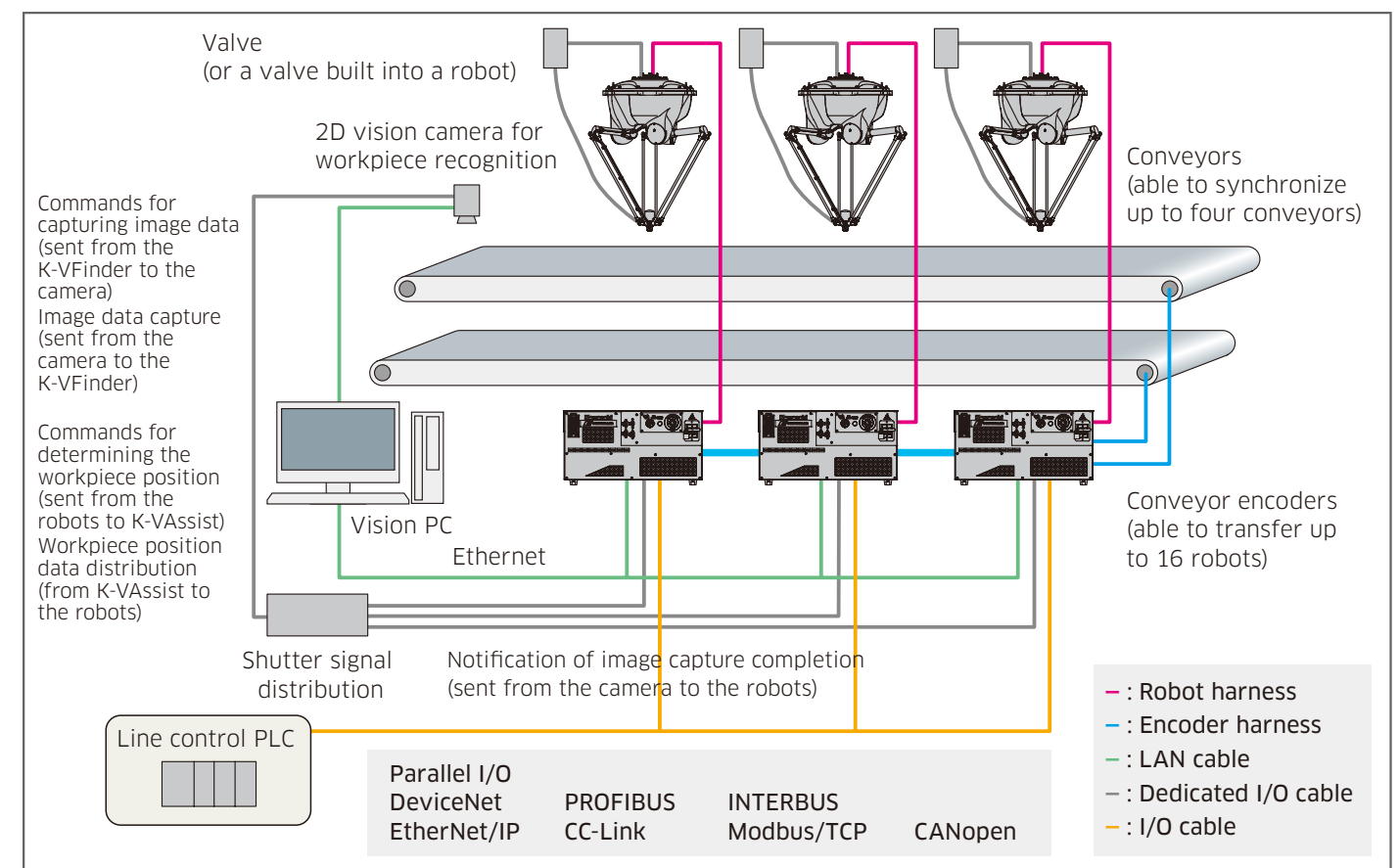

# E series

Kawasaki has incorporated more than 45 years of experience as a robot industry leader into the development of the most technically advanced controller available. The E Controller combines high performance, unprecedented reliability, a host of integrated features and simple operation, all in a compact design.



## Features

### Compact

The overall volume of the E Controller has been reduced compared with the previous model. The small footprint of this compact controller allows for installation in “high-density” applications. For further space saving options, an upright-position or stacked installation is possible, without impeding performance.

### User-friendly operation

The easy-to-use teach pendant now incorporates motor power and cycle start at your fingertips. Multiple information screens can be displayed simultaneously. The intuitive teaching interface is simple to use.

### Programming ease & flexibility

A rich set of programming functions come standard with the E Controller to support a wide range of applications. Functions can be combined and easily configured within a system to suit a particular application. Also, the powerful Kawasaki AS Programming Language provides sophisticated robot motion and sequence controls.

### Advanced technologies

The enhanced CPU capacity allows for more accurate trajectory control, faster program execution, and quicker loading and saving of files. In addition, memory has been expanded to meet the need for higher program storage capacity. The controller comes equipped with a USB port for external storage devices.

### Easy maintenance

Modular components with limited cables translate into easy diagnostics and maintenance. A host of maintenance functions are available, including self-diagnostics on hardware and application errors to minimize troubleshooting and reduce MTTR (Mean Time To Repair). Remote diagnostics via the web server function enables service support from anywhere in the world.

### Expandable

Numerous communication fieldbuses are available for controlling peripheral devices. The Kawasaki K-Logic sequencer software can be combined with user customized interface panels on the teach pendant.

### Teach pendant

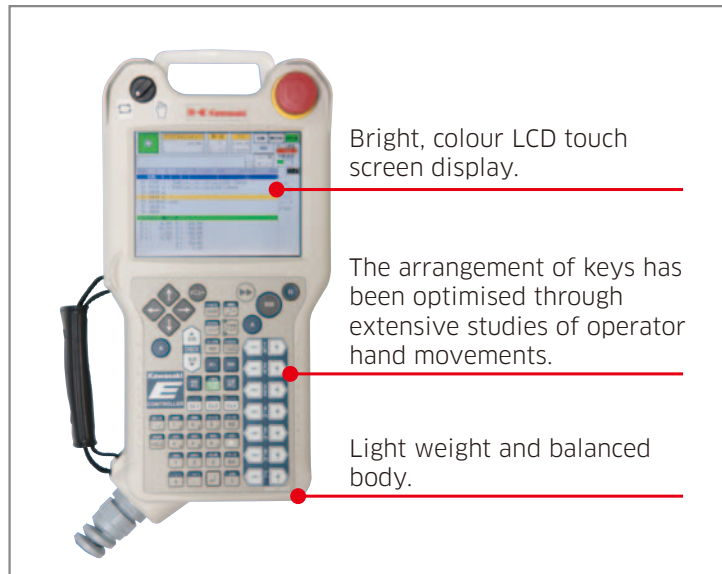

## Specifications

		Standard	Option
America		E97	
Europe		E91	
Japan & Asia		E94	
Dimensions (mm)		W550×D580×H268	
Structure	E97	Open structure with direct cooling system	Enclosed structure
	E91	Enclosed structure / Indirect cooling system	
	E94	Open structure with direct cooling system	Enclosed structure
Memory capacity (MB)		8	
General purpose signals	External operation	Motor power off, Hold	
	Input (Channels)	32	Max. 96
	Output (Channels)	32	Max. 96
Operation panel		E-Stop switch, teach/repeat switch, control power light (Cycle start, motor-on, hold/run, and error reset are activated from the teach pendant.)	
Mass (kg)		40	
Power requirements		AC200-230V ±10%  50/60Hz  1ø Class-D earth connection (Earth connection dedicated to robots), leakage current: Maximum 100mA	
Environmental condition	Ambient temperature (°C)	E97	0 - 45
		E91	0 - 40
		E94	0 - 45
Relative humidity (%)		35 - 85 (no dew, nor frost allowed)	
Body color		Munsell 10GY9/1 equivalent	
Teach pendant		TFT color LCD display with touch-panel, E-Stop switch, teach lock switch, Enable switch	
Interface		USB, Ethernet (100BASE-TX), RS-232C	

## External view & dimensions

