

HIGH-SPEED, HIGH-PERFORMANCE INDUSTRIAL ROBOTS

The new R-Series Robots are setting the benchmark for all small to medium duty industrial robots. The compact design, along with industry leading speed, reach and work range make the R-Series Robots ideal for a wide range of applications throughout a multitude of diverse industries.

RS30N

Payload	30 kg
Horizontal Reach	2,100 mm
Vertical Reach	3,697 mm
Repeatability	±0.07 mm
Maximum Speed	13,400 mm/s

Applications

- Assembly
- Dispensing
- Inspection
- Machine Tending
- Material Handling
- Material Removal
- Welding



ULTRA HIGH-SPEED OPERATION

The new lightweight arm along with high-output high-revolution motors provide industry leading acceleration and high-speed operation. The acceleration rate automatically adjusts to suit the payload and robot posture to deliver optimum performance and the shortest cycle times.

WIDE WORK RANGE

In addition to extending the robot's maximum reach, the rotation range of each axis has also been increased. The extended motion range translates to a larger usable work area with minimal dead-space and greater flexibility.

ENVIRONMENTAL PROTECTION

The R-Series incorporates a double-seal construction on all axes and the electrical connections are water-resistant offering an IP67 classification for wrist and IP65 for the remaining axes. If a wash-down arm is required, the entire robot can be provided as IP67.

HIGH TORQUE

High-output motors, combined with a rigid arm construction, allow for superior wrist torque and load capacity.

INTEGRATED FEATURES

Built-in pneumatic lines and internal wiring are standard. Mounting pads and taps are provided to allow easy installation of additional cabling, tubing or equipment.

SPACE SAVING

The slim arm design requires very little floor space. Multiple robots can be installed in "high-density" applications without impeding performance.

EASY MAINTENANCE

The Kawasaki design requires very little maintenance while boasting industry leading mean time between failures (MTBF).

MOTION RANGE & DIMENSIONS

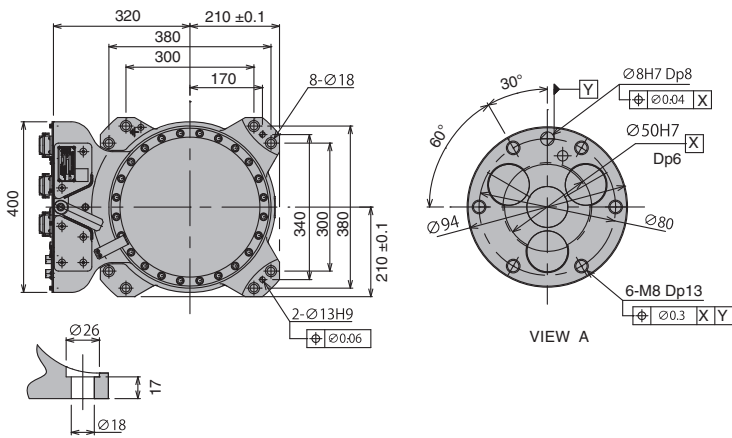
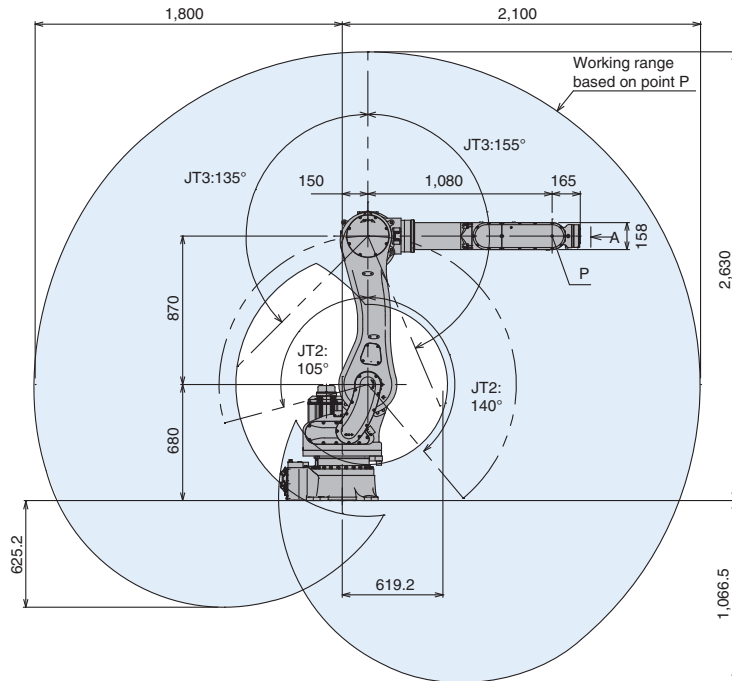

INSTALLATION DIMENSIONS

(mm)

Note: Detailed drawings are available upon request.

Simple friendly

RS30N SPECIFICATIONS

Type	Articulated		
Degrees of Freedom	6 axes		
Payload	30 kg		
Horizontal Reach	2,100 mm		
Vertical Reach	3,697 mm		
Repeatability	±0.07 mm		
Maximum Speed	13,400 mm/s		
Work Envelope (degrees) & Maximum Speed (degrees/s)	Axis	Motion Range	Maximum Speed
	JT1	±180°	180°/s
	JT2	+140° ~ -105°	180°/s
	JT3	+135° ~ -155°	185°/s
	JT4	±360°	260°/s
	JT5	±145°	260°/s
Wrist Load Capacity	Axis	Maximum Torque	Moment of Inertia
	JT4	210 N·m	16.8 kg·m ²
	JT5	210 N·m	16.8 kg·m ²
JT6	130 N·m	6.6 kg·m ²	
Motor(s)	Brushless AC Servomotor		
Brakes	All axes		
Hard Stops	Adjustable mechanical stopper JT1/JT2/JT3		
Mass	555 kg (excluding Options)		
Body Color	Kawasaki Standard		
Installation	Floor, wall, ceiling		
Environmental Conditions	Temperature	0 ~ 45° C	
	Humidity	35 ~ 85 % (no dew, nor frost allowed)	
	Vibration	Less than 0.5 G	
Protection Classification	Wrist: IP67 Base: IP65 * Equivalent		
Built-in Harness	Sensor harness 12 inputs, 24VDC, GND		
Internal Wiring	14 wires, inside robot arm		
Built-in Utilities	Pneumatic piping (∅10 x 2 lines)		
Options	IP67 entire arm JT1/JT2 motor cover Linear track options Riser (300/600 mm) Base plate Double/single solenoid valves (4 units max.) Air cleaning equipment (filter, regulator, mist separator) Limit switch JT1		
Controller	E32 (see E Controller data sheet for specifications)		

Assembly • Cutting • Dispensing • Grinding • Handling • Inspection • Packaging • Painting • Palletizing • Polishing • Tending • Welding

Kawasaki Robotics (USA), Inc.

United States
 28140 Lakeview Drive
 Wixom, Michigan 48393
 Phone (248) 446-4100
 Email sales@kri-us.com

Canada
 Phone (905) 304-7784

Mexico
 Phone (52) 33-3110-1895

www.kawasakirobotics.com

RS30N - REV04/11
 © Kawasaki Robotics (USA), Inc. All rights reserved.
 Technical specifications subject to change without notice.